



PRECAST CONCRETE FLOORING GUIDE

BISON PRECAST

BUILDING A SUSTAINABLE BUSINESS

BISON PRECAST

As a leading manufacturer of high quality precast concrete flooring and structural precast components, it's our experience and technical expertise that enables us to develop sustainable solutions to meet the most demanding of projects.

Bison Precast has been a part of the building industry for over a century, this experience enables us to work with you to design and engineer tailor-made flooring products to fit your scheme, timescale and budget. Our products are designed with customers in mind. Our high-performance insulated ground floor system Jetfloor is the ideal solution to help housebuilders easily meet the requirements of Part L regulations, providing a flexible approach to 'U' values and improved Psi values due to our unique Psi-Block®. For upper floors, our Hollowcore floor units can be supplied with our mechanically inserted lifting hooks, to allow for faster, safer and more accurate installation on site.

Sustainability is at the heart of everything we do. Throughout our Bison operation we are making continuous improvements to reduce the embodied carbon in our precast concrete products. This not only helps us achieve our own carbon emission targets, but helps customers meet their targets too.

With core values including safety, sustainability and fairness, you can be confident to build with Bison.

CONTENTS

JETFLOOR	4-9
BEAM & BLOCK	10-15
HOLLOWCORE	16-21
CASE STUDY - JETFLOOR	22-23
STAIRS & LANDINGS	24-27
TECHNICAL SERVICES	28
FORTERRA COMPLETE RANGE	30

**BRINGING TOGETHER STRUCTURAL
AND THERMAL PERFORMANCE IN ONE
INSULATED GROUND FLOOR SOLUTION**

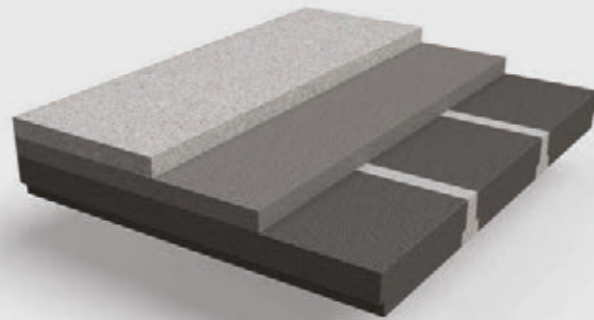

EXPANDED POLYSTYRENE BLOCKS

Lightweight, easy to handle expanded polystyrene blocks enable rapid coverage of large areas of floor, available in a range of configurations providing a flexible approach to achieving 'U' values.



PRESTRESSED BEAMS

Jetfloor consists of standard 150mm and 225mm deep prestressed concrete beams positioned at varying centres dependent on load conditions.

BISON PRECAST

JETFLOOR INSULATED GROUND FLOORS

Our Jetfloor system, has been the market-leading solution for thermally insulated structural ground floors since its introduction in 1982 and BBA Certified since 1988.

FOR JETFLOOR CALL 01636 832000

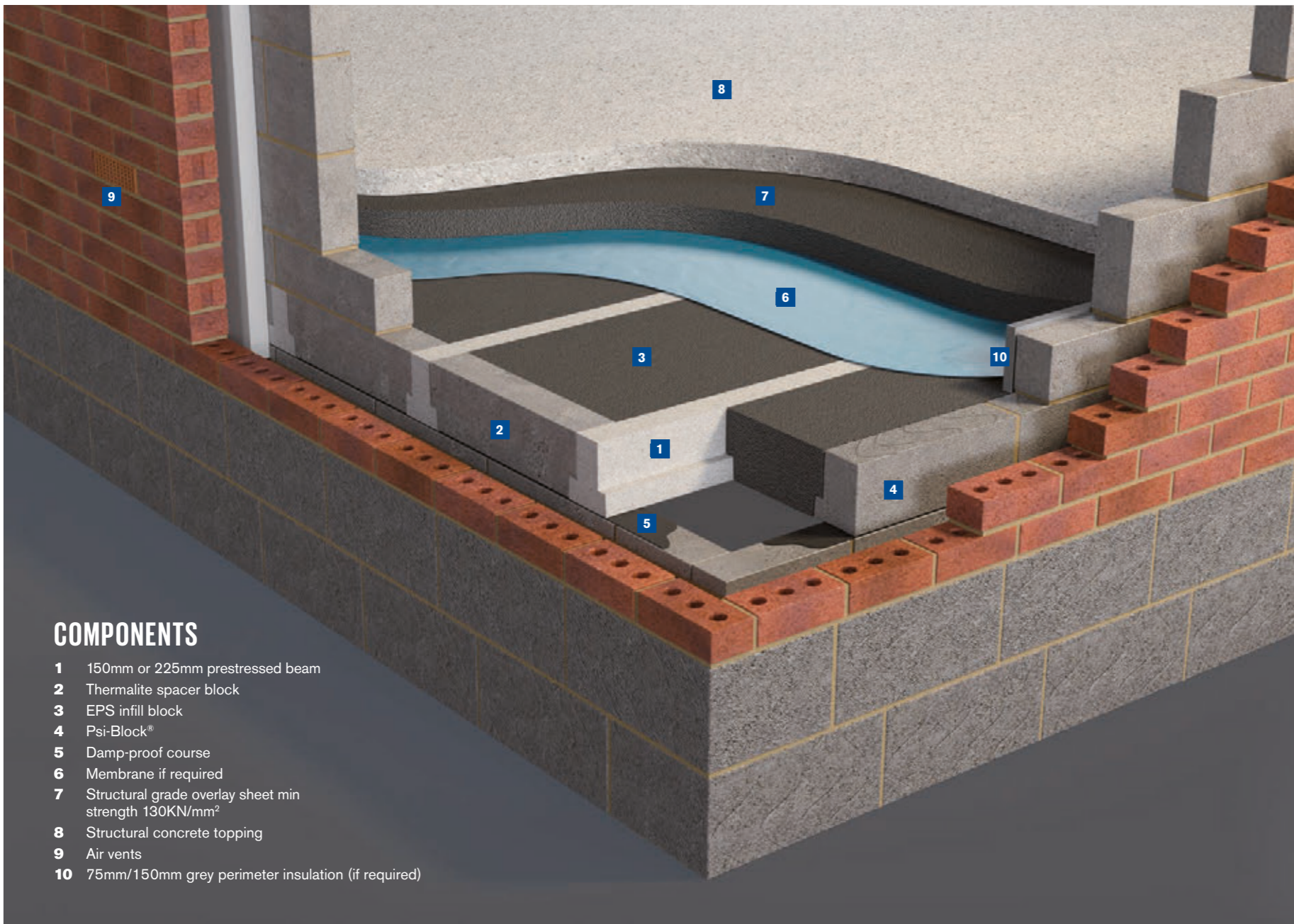

COMPONENTS

- 1 150mm or 225mm prestressed beam
- 2 Thermalite spacer block
- 3 EPS infill block
- 4 Psi-Block®
- 5 Damp-proof course
- 6 Membrane if required
- 7 Structural grade overlay sheet min strength 130KN/mm²
- 8 Structural concrete topping
- 9 Air vents
- 10 75mm/150mm grey perimeter insulation (if required)

JETFLOOR SYSTEM OVERVIEW

Jetfloor brings together structural and thermal performance in one insulated ground floor solution.

Jetfloor consists of standard 150mm and 225mm deep prestressed concrete beams positioned at varying centres dependent on load conditions.

The beams are infilled with expanded polystyrene (EPS) blocks which are supplied in lightweight easy to handle lengths, enabling rapid coverage of large areas of floor. The EPS blocks are available in a range of configurations providing a flexible approach to achieving 'U' values.

The unique Jetfloor Psi-Block® reduces thermal linear bridging and improves the Psi value at floor to wall junctions helping reduce the overall dwelling emission rate (DER).

The unique profile of the Psi-block also adds a level of robustness during the build sequence that is not provided by other industry competitors. The floor is completed with a reinforced structural concrete topping laid over a minimum of 80mm EPS sheet insulation.

Other thicknesses of structural grade EPS sheet can be provided. Discuss your requirements with our team today.

Bison Precast concrete specification:
Reinforced structural concrete topping grade C28/35 with thickness of 70/75mm to suit top sheet insulation thickness.

Part L Compliance

To comply with the latest Part L Building Regulations, all new homes must produce 31% less CO₂ emissions than previously stated. As a result, the maximum permitted u-values for floors has reduced to 0.15W/m²K in a move to increase the thermal performance of ground floors.

Jetfloor is the perfect solution to easily meet these requirements with a range of options to suit your build programme and achieve u-values as low as 0.11W/m²K.

Contact our **sales team** today to find out more.

THERMAL PERFORMANCE

EPS blocks are available in a range of configurations providing a flexible approach to achieving u-values as low as 0.11W/m²K.

Improved Psi value due to unique Psi-Block®.

SUSTAINABILITY

Reduced dwelling emission rates.

Accredited to BS EN 14001 and BES 6001 responsible sourcing.

Jetfloor provides a future-proofed robust solution for housebuilders, specifiers and homeowners.

COST OF CONSTRUCTION

Reduced excavation and spoil removal.

Designed to meet individual house type requirements, eliminating unnecessary waste.

Increased speed of build.

SERVICE

Available nationwide.

Supply only or supply and install.

Comprehensive in-house technical support.

Polystyrene off cuts collected and recycled.

Dedicated account handlers and design team representative.

QUALITY

CE marked to BS EN 15037 and certified by the BBA since 1988 to latest relevant codes and standards.

Beams are CE marked against BS EN 15037.

Manufactured in accordance with BS EN ISO 9001.

The entire Jetfloor system is BBA Certified.

STRUCTURAL PERFORMANCE



PRESTRESSED BEAM DETAILS

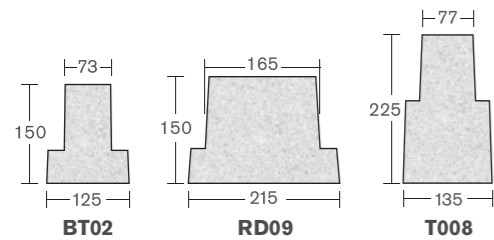

Beam Reference	Width (mm)	Height (mm)	Weight (kN/m)	Weight (kg/m)	Max Length
BT02	125	150	0.326	32.8	5.5
RD09	215	150	0.622	64.2	6.8
T008	135	225	0.576	58.7	7.9

The load-span tables opposite are given as a guide only. Further advice is available on request.

CAMBER DETAILS

Bison Precast prestressed concrete beams exhibit an upward curve known as camber which is a result of the compressive force near the bottom generated by the prestressing tendons. An allowance of span/300 should be taken into account in floor finishes or bearing levels.

BLOCK DETAILS

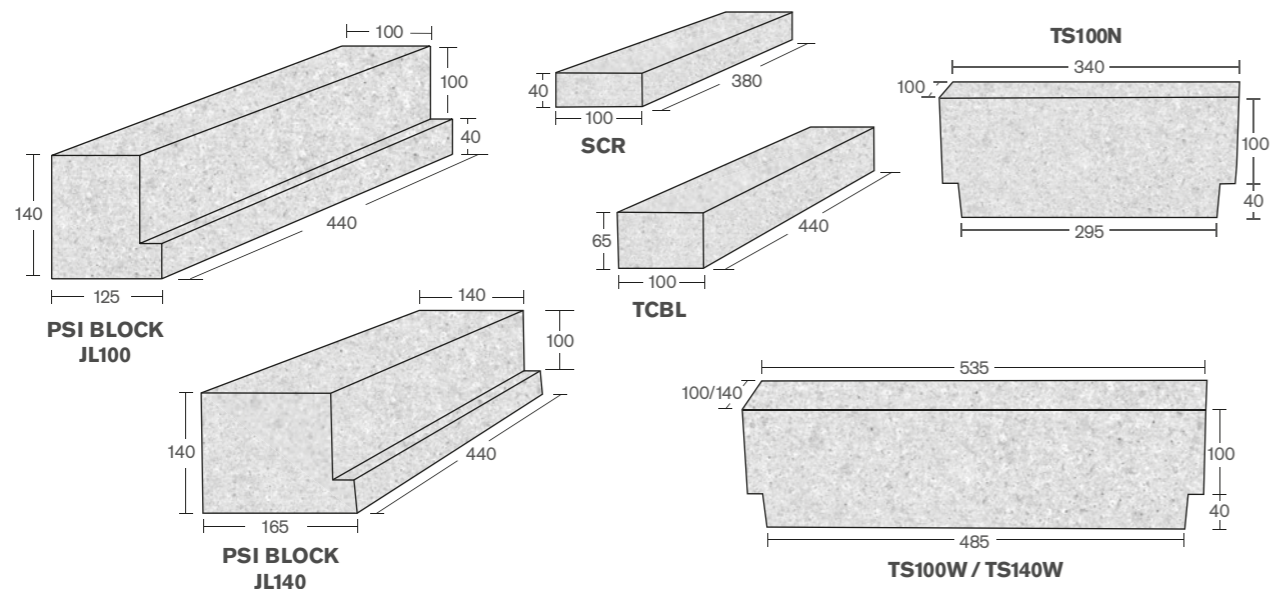

JETFLOOR LOAD-SPAN TABLES

Based on floor finishes of 70mm thick concrete topping having minimum strength class C 28/35 reinforced with either polypropylene fibres, steel fibres or steel reinforcement mesh on insulating sheet material of minimum compressive strength 130kN/mm².

BISON REF	BEAM SIZE (MM)	EFFECTIVE BEAM CENTRES (MM)	SLAB SELF WEIGHT KN/M ²	SPANS INDICATED BELOW ALLOW FOR CHARACTERISTIC IMPOSED LOAD PLUS SELF WEIGHT PLUS 1.68KN/M ² FOR FINISHES					
				CHARACTERISTIC IMPOSED LOAD KN/M ²					
				1.5	2.0	2.5	3	4	5
				Clear span (m)					
NJB1	150 x 125	610	0.56	4.45	4.20	3.95	3.75	Contact Bison Precast with specific requirements	
NJB2	150 x 125	515	0.66	4.80	4.50	4.25	4.05		
NJB3	150 x 125	420	0.80	5.25	4.90	4.65	4.45		
NJR1	150 x 215	700	0.94	5.75	5.45	5.15	4.90		
NJR2	150 x 215	605	1.08	6.10	5.75	5.45	5.20		
NJR3	150 x 215	510	1.27	6.50	6.15	5.85	5.60		
NJT1	225 x 135	620	0.97	6.95	6.60	6.25	5.95		
NJT2	225 x 135	525	1.14	7.45	7.05	6.70	6.40		
NJT3	225 x 135	430	1.38	7.80	7.60	7.25	6.90		
				ψ ₀ = 0.7	ψ ₁ = 0.5	ψ ₂ = 0.3	ψ ₀ = 0.7	ψ ₁ = 0.7	ψ ₂ = 0.6
				Category A/B - Domestic, residential / office areas				Category C/D - Congregation areas / shopping	
FLOOR CATEGORY OF USE (FROM BS EN 1991-1-1:2002). USED FOR DETERMINING THE COMBINATION OF ACTIONS FACTORS									

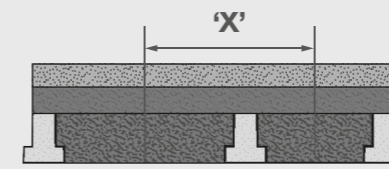

Where 'X' equals effective beam centres



A ROBUST SOLUTION FOR COST
EFFECTIVE SUSPENDED FLOORS SUITABLE
FOR USE ON GROUND AND UPPER FLOORS



BEAM & BLOCK SYSTEMS



INVERTED T-BEAMS



SPLIT BLOCKS

BISON PRECAST

BEAM & BLOCK FLOORING

Bison Precast beam & block flooring system is quick, easy and economical to install. It offers numerous advantages, including improved acoustic performance and fire resistance.

FOR BEAM & BLOCK CALL 01636 832000



**DIFFERENT BLOCK
OPTIONS ARE AVAILABLE
WITH OUR BEAMS TO
SUIT YOUR BUDGET**



COMPONENTS

- 1 150mm or 225mm prestressed beam
- 2 100mm deep building block infill
- 3 Split course block
- 4 Damp-proof course
- 5 Insulation (if required)
- 6 Membrane (if required)
- 7 Air vents
- 8 Finish screed/concrete topping to architect's specification

BEAM & BLOCK SYSTEM OVERVIEW

Beam & Block is a robust solution for cost effective suspended floors. It is suitable for use on ground and upper floors on all kinds of construction, from residential to commercial buildings.

The system is quick, easy and economical to install and offers numerous advantages including improved acoustic performance and fire resistance.

Particularly suitable on intermediate floors for houses, where sound reduction, fire resistance and thermal mass are amongst its key benefits.

The system consists of inverted 'T' beams with either lightweight aircrete (Thermalite) or aggregate block infill.

Bison can provide Beam only, Beam & Block or Beam & Splits. Speak to our team today about your on site requirements.



QUALITY SERVICE

Available nationwide either supply only or supply and fix.

Complies with all relevant standards and manufactured in accordance with BS EN 15037.

SUSTAINABLE

The Bison Precast beam & block flooring system consists of inverted pre-stressed T-beams with either aircrete or aggregate block infill. Sound reduction, fire resistance and thermal mass are amongst its key benefits which can contribute to meeting the thermal requirements of Building Regulations and the uplift to Part L.

FLEXIBILITY

Range of beam types available for house builds, apartments and larger scale residential dwellings such as care homes and retirement living schemes.

Ideally suited to difficult brownfield sites.

SIMPLICITY OF CONSTRUCTION

Quick to install.

Working platform for early access for follow on trades.

HIGH PERFORMANCE

Prestressed beams span further than other methods, reducing foundation costs.

Superior levels of fire resistance and sound reduction.

Greater load-span capability enabling use in a wide variety of applications.

Unaffected by damp, rot or vermin.



BEAM & BLOCK LOAD-SPAN TABLES

SPANS INDICATED BELOW ALLOW FOR CHARACTERISTIC IMPOSED LOAD PLUS SELF WEIGHT PLUS 1.8KN/M² FOR FINISHES

BISON REF	BEAM SIZE (MM)	EFFECTIVE BEAM CENTRES (MM)	SLAB SELF WEIGHT KN/M ²	CHARACTERISTIC IMPOSED LOAD KN/M ²					
				1.5	2.0	2.5	3	4	5
				Clear span (m)					
IJ1	150 x 125	525	1.86	4.10	3.90	3.75	3.60	3.35	3.10
IJ2	150 x 125	413	1.96	4.55	4.35	4.20	4.00	3.75	3.50
IJ3	150 x 125	300	2.15	5.30	5.05	4.85	4.65	4.35	4.10
RDJ4	150 x 215	615	2.10	5.35	5.10	4.90	4.75	4.40	4.15
RDJ5	150 x 215	503	2.25	5.85	5.60	5.40	5.20	4.85	4.55
RDJ6	150 x 215	390	2.47	6.45	6.25	6.05	5.80	5.45	5.15
TJ1	225 x 135	535	2.30	6.45	6.15	5.90	5.70	5.35	5.00
TJ2	225 x 135	422	2.51	7.10	6.80	6.55	6.35	5.95	5.60
TJ3	225 x 135	310	2.89	7.75	7.75	7.45	7.20	6.80	6.40

$\psi_0 = 0.7$ $\psi_1 = 0.5$ $\psi_2 = 0.3$ $\psi_0 = 0.7$ $\psi_1 = 0.7$ $\psi_2 = 0.6$

Category A/B - Domestic, residential / office areas Category C/D - Congregation areas /shopping

FLOOR CATEGORY OF USE (FROM BS EN 1991-1-1:2002). USED FOR DETERMINING THE COMBINATION OF ACTIONS FACTORS

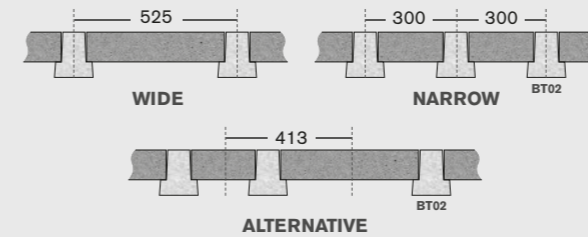

PRESTRESSED BEAM DETAILS

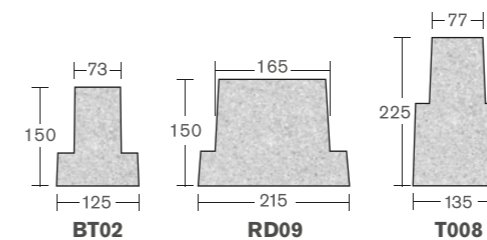

Beam Reference	Width (mm)	Height (mm)	Weight (kN/m)	Weight (kg/m)	Max Length
BT02	125	150	0.326	32.8	5.5
RD09	215	150	0.622	64.2	6.8
T008	135	225	0.576	58.7	7.9

The load-span tables are given as a guide only. Further advice is available on request.

GAMBER DETAILS

All prestressed concrete beams exhibit an upward curve known as camber which is a result of the compressive force near the bottom generated by the prestressing tendons. An allowance of span/300 should be taken into account in floor finishes or bearing levels.

VIEW OUR CONSTRUCTION DETAILS AT FORTERRA.CO.UK/BISON/BEAM-BLOCK-FLOORS

**PRESTRESSED HOLLOWCORE UNITS
FORM PART OF THE COMPREHENSIVE
RANGE OF PRECAST CONCRETE FLOORING
PRODUCTS FROM BISON PRECAST**



HOLLOWCORE FLOORS

Hollowcore floor slabs have excellent sound-reducing qualities, durability and inherent fire resistance making them the ideal solution for apartments, care homes, hospitals, schools, universities, hotels, custodial facilities, industrial and commercial projects.



SOLID FLOORS

Our solid floor prestressed units provide effective solutions for projects in a variety of sectors. They are manufactured in 100mm depths and are suitable for use in high-rise apartments, stadia, industrial and commercial projects.

FOR HOLLOWCORE CALL 01636 832000



BISON PRECAST

HOLLOWCORE FLOORING PRODUCTS

**The structural floor solution
for all building sectors.**



HOLLOWCORE 150, 200 AND 250MM DEEP SECTIONS

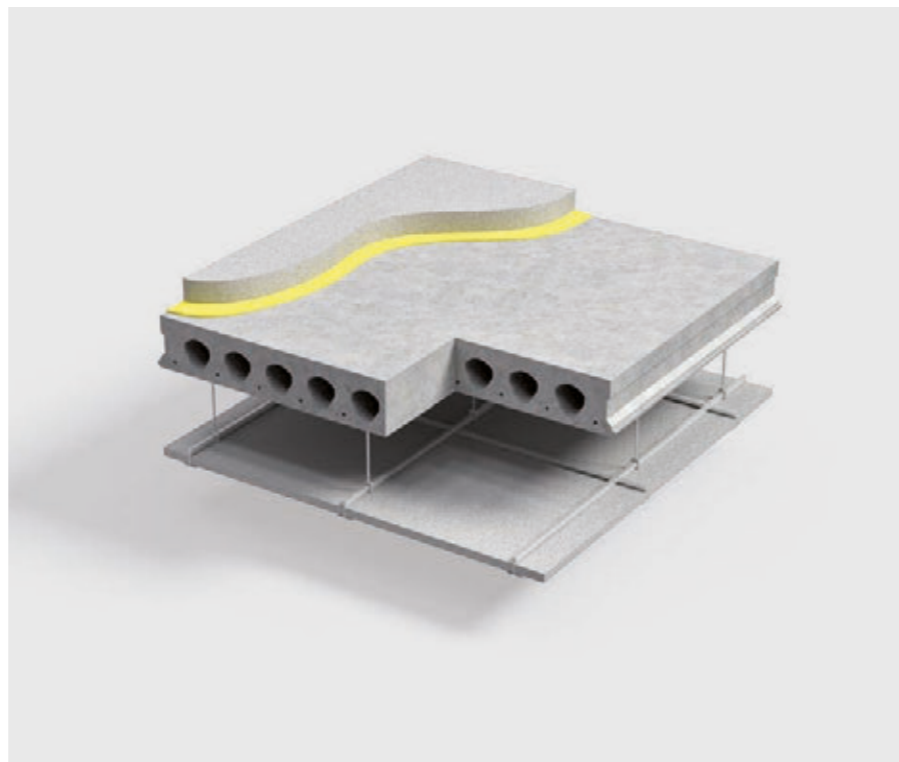

HOLLOWCORE SYSTEM OVERVIEW

Bison's Hollowcore system provides a bespoke, modular off-site solution, with a market leading service from start to finish.

Available in 150, 200 and 250mm deep sections, Hollowcore can be supplied nationwide, either on a supply and install basis by specialised teams from Bison Precast, or supply only for installation by the main contractor.

We also offer competitive lead times on our Hollowcore system, get in touch today to find out more.

Design and Estimate

Quotation Preparation - On receipt of detailed enquiry information, a comprehensive quotation is prepared. This is based on a review of all design and installation parameters, and in accordance with the code of practice for Safe Installation Precast Flooring.

Planning and Installation

Preliminary Site Visit - On this visit the Bison Precast Project Manager will hand over to the client's on site representative a copy of the Construction Safety File, this document will contain specific guidance for the Client prior to, during and post installation of the precast units. On the day of installation and following RA/MS reviews and inductions the team will install Hollowcore in accordance with the construction drawings.

Separating floors are required to comply with Part E of the Building Regulations. In order for a new development to meet the standard, pre-completion testing will be required to demonstrate the level of sound reduction has been incorporated into the building.

The alternative is to adopt the standard set of details which have been tested by Robust Details and are contained within their handbook.

CAN BE USED IN MASONRY, STEEL & CONCRETE STRUCTURES

EXCELLENT SOUND & FIRE RESISTANCE

Compatible with robust details for Part E & Document B of the building regulations.

COST OF CONSTRUCTION

Clear, unpropped spans provide an immediate working platform.

Fast and simple to install.

Easier installation of services, with holes and notches preformed during manufacture.

SERVICE

Bespoke design service.

Available nationwide either supply only or supply and install.

QUALITY

Complies with all relevant standards and manufactured in accordance with BS EN ISO 9001 and BS EN ISO 140001.

Units are CE marked against BS EN 1168.

Factory manufacture to consistent quality standards.

HOLLOWCORE LOAD-SPAN TABLES

Largely because of fast on-site construction, Bison hollowcore floors are one of the most economic flooring solutions for the widest variety of situations including masonry, steel and concrete structures for residential, retail, commercial and industrial buildings.

The table is given as a guide only. When using maximum spans, consideration must be given to the effect of camber and deflection on partitions or finishes. Further advice is available on request.

Hollowcore Load/Span - Non Composite with 2.1kN/m² allowance for finishes.



BISON REF	UNIT DEPTH (MM)	SLAB SELF WEIGHT KN/M ²	SPANS INDICATED BELOW ALLOW FOR CHARACTERISTIC IMPOSED LOAD PLUS SELF WEIGHT PLUS 2.1KN/M ² FOR FINISHES							
			CHARACTERISTIC IMPOSED LOAD KN/M ²							
			1.5	2.0	2.5	3	4	5	5	7.5
Clear span (m)										
150	150	2.47	7.40	7.35	7.35	7.00	6.65	6.35	5.75	5.00
150 (sound slab)	150	3.02	7.35	7.35	7.35	7.00	6.70	6.35	5.95	5.20
200	200	3.10	8.85	8.85	8.80	8.80	8.65	8.30	7.70	6.70
250	250	3.47	9.75	9.75	9.75	9.75	9.60	9.10	8.90	7.95
			$\psi_1 = 0.7$	$\psi_2 = 0.5$	$\psi_2 = 0.3$	$\psi_0 = 0.7$	$\psi_1 = 0.7$	$\psi_2 = 0.6$	$\psi_0 = 1.0$	$\psi_1 = 0.9$
			Category A/B - Domestic, residential / office areas			Category C/D - Congregation areas /shopping			Category E - Storage areas	
FLOOR CATEGORY OF USE (FROM BS EN 1991-1-1:2002), USED FOR DETERMINING THE COMBINATION OF ACTIONS FACTORS										

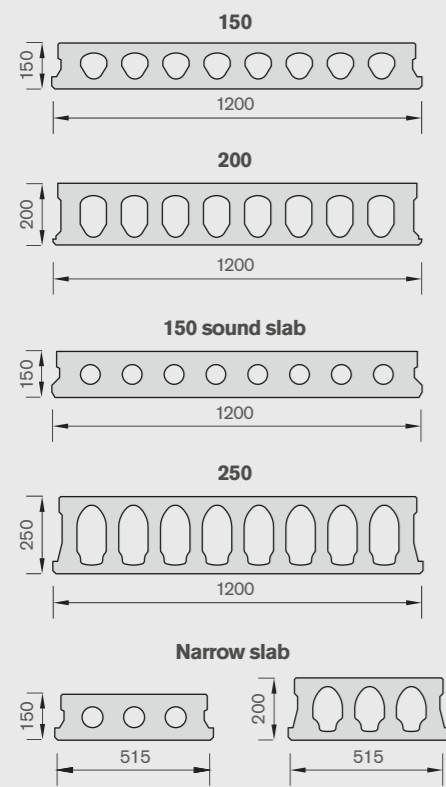

Note 1

The maximum clear spans shown in the table above are based on:

- 1 hour fire rating
- XC1 exposure class (internal upper floor use)
- Minimum 4.0Hz Natural Frequency
- Non-brittle floor finishes

The clear span lengths make no allowance for service penetrations through the floor or additional concentrated loads from items such as masonry partitions etc. Such additions may reduce the possible clear span.

Note 2

The 1.50kN/m² live load in the table above is shown to be category A residential use, but may also be applied to category H roof use. The 3.00kN/m² live load in the table above is shown to be category C congregational use which will also apply to classroom use.

Note 3

Bison Precast can also offer:

- The manufacture of solid prestressed planks with depths of 100mm, 150mm, & 200m.
- Floor designs to act compositely with a directly applied structural concrete topping finish over (topping supplied and placed by others than, with no cost to Bison).

We do not provide load span tables or generic guidance for these items due to their bespoke nature, so please contact technicalquery@bison.co.uk for assistance with enquiries relating to this, or any other technical matters you may have.

For commercial/quotation enquiries and timescales please contact our estimating services at concrete@bison.co.uk.

BALCONY FIXING DETAILS TO PRECAST FLOORING

To accommodate a steel balcony, an L shape bracket is bolted to the balcony via the thermal break and bolted through the slab.

Reinforcement can be added into the top section of the slab to resist any large forced being transmitted to it. This method can be used for both Hollowcore and RC slabs.

Figure 1: Typical steel balcony fixing to floor side edge

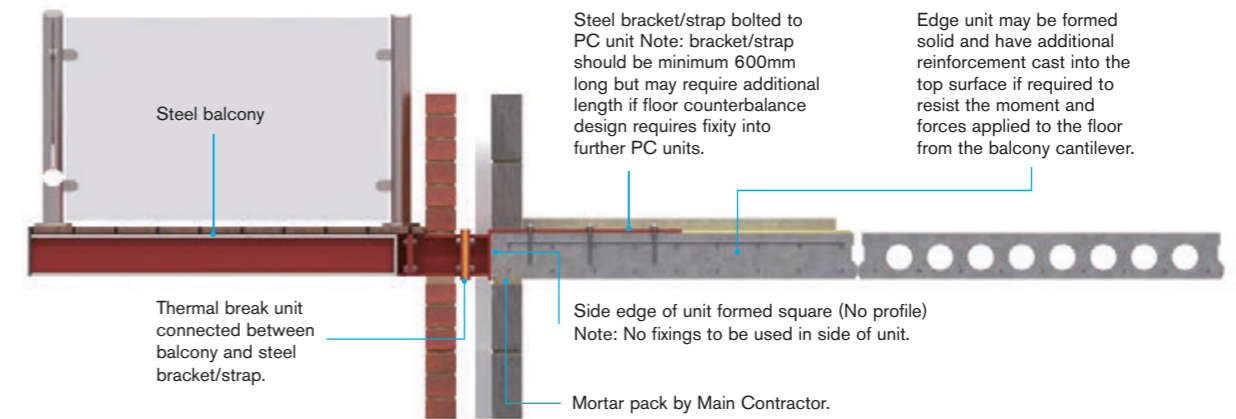
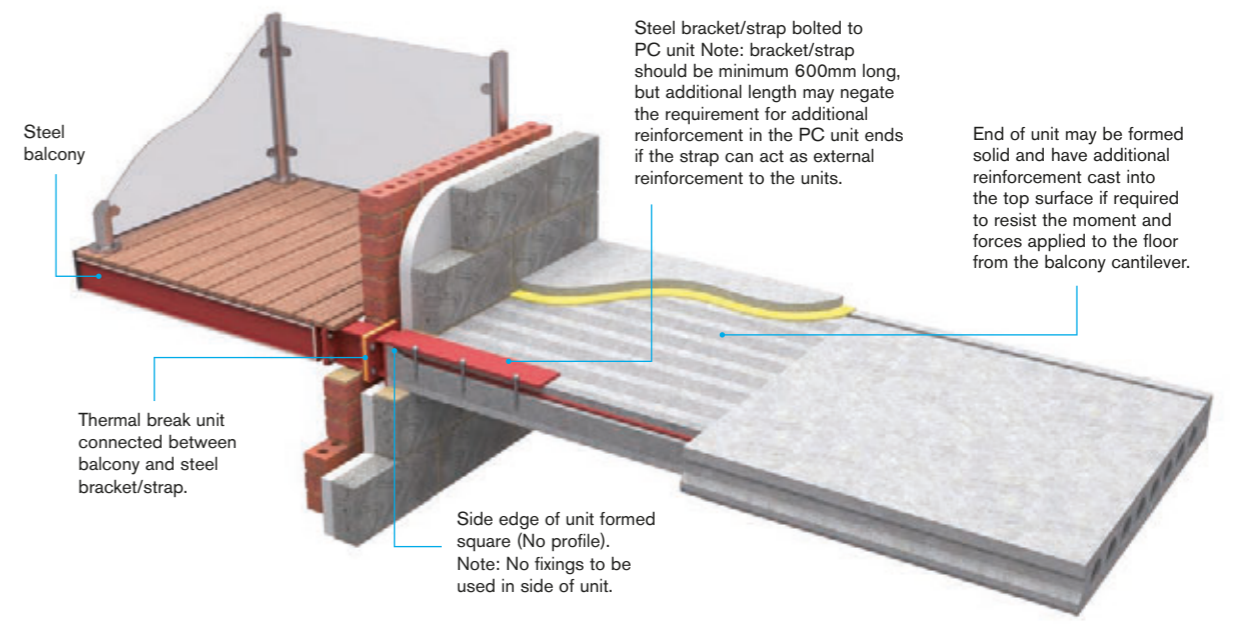

Figure 2: Typical steel balcony fixing to floor end bearing



**JETFLOOR PROVIDES
EASE OF INSTALLATION
WITH LIGHTWEIGHT
EPS BLOCKS AND
NO CLIPS OR PINS.**



CASE STUDY **SEWSTERN SELF BUILD**

Client: HSSP Architects

Products: Jetfloor, Beam & Block to upper floors

Sector: Residential

Location: Leicestershire

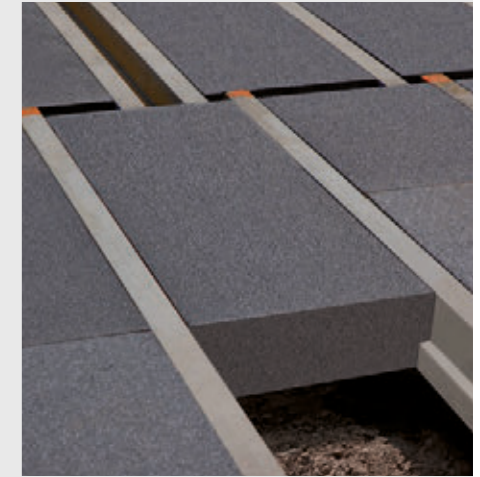

Don Lee, an engineer with no experience in property development, planned to build his own home on land he owned in the village of Sewstern, in Leicestershire. Mr Lee opted for a modular build system, that included Jetfloor to provide the benefits of a thermal floor design.

Explaining his decision to use Jetfloor, Mr Lee explained: "One of my main reasons for using Jetfloor was its excellent value for money, particularly when compared with suspended in-situ concrete or old-fashioned wooden floors. It's also better for the environment as it will help reduce heat loss and lower my energy bills.

"The choice of beam & block over timber for the upper floors was driven by the much-improved sound transmission you get with a solid concrete floor and the design flexibility offered by the increased spans available in concrete."

Richard Cooper, Director of HSSP Architects, commented: "Mr Lee's approach was unusual when compared to most other self-builders who tend to go with brick and timber. However, Mr Lee really wanted to push the envelope with Jetfloor as it saved him money and is more eco-friendly.

"Technically it was straightforward to design and specify for this development, and though it was slightly unusual, we were able to work closely with Bison Precast in delivering the project to everyone's satisfaction."

TO DISCUSS YOUR NEXT PROJECT CALL 01636 832000

INDIVIDUALLY DESIGNED AND
MANUFACTURED TO MEET THE SPECIFIC
REQUIREMENTS OF EACH PROJECT

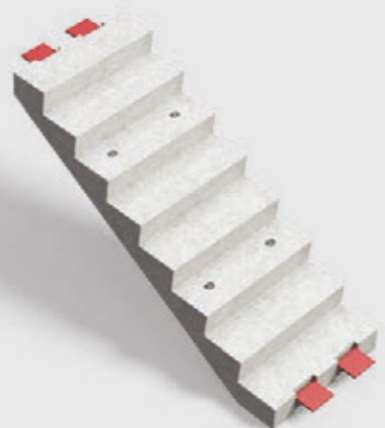

STANDARD STAIRCASE

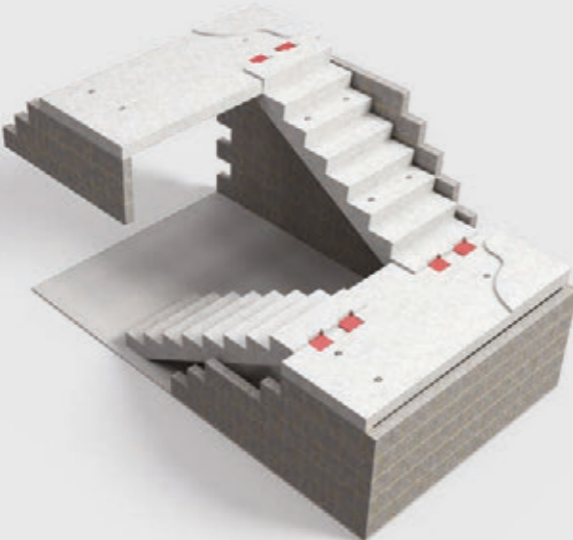

STAIRCASE WITH LANDINGS



BISON PRECAST

STAIRS AND LANDINGS

Providing stairs, landings and balcony
units to the Nations housebuilders
for over 30 years.

PRECISION BUILT STAIRCASES LANDINGS & BALCONIES

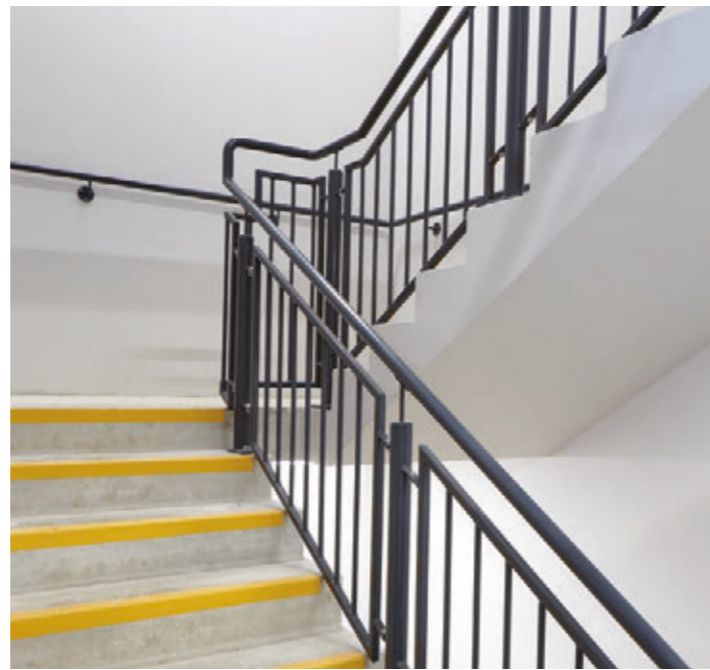

STAIRS AND LANDINGS SYSTEM OVERVIEW

Bison Precast's steel moulds for stairs, landings and balcony units can meet the requirements of even the most demanding projects. Close working with project architects and designers ensures the structural and commercial viability of its products, whether standard or bespoke.

Each precast concrete unit is designed and manufactured to meet the specific requirements of each project, with our in-house design team on hand to provide immediate guidance and information.

The use of precast staircases offers immediate and safe access to upper levels during the build process.

Our staircases are manufactured in precision steel moulds, and we can also provide non-standard staircases utilising high quality bespoke moulds.

Stairs need leveling and shimming before installation.

Did you know we also manufacture pre-cast stairs for commercial projects and stadiums?

For more information visit our website www.forterra.co.uk/stadia/stairs-landings

HIGH PERFORMANCE

Inherent fire resistance and excellent sound reduction qualities.

Factory manufactured for improved consistency, accuracy and quality.

QUALITY

All precast concrete products and processes comply with relevant standards and are manufactured in accordance with BS EN ISO 9001.

Stair components are CE marked against BS EN 14843.

Accredited to BS EN 14001 and BES 6001 responsible sourcing.

COST OF CONSTRUCTION

No propping or expensive formwork.

Immediate safe access for follow-on-trades.

Increased speed of build.

Suitable for all construction types, in all sectors.

SERVICE

Available nationwide either supply only or supply and install.

Design support provided from concept through to project completion.

On-going technical support before and after installation.

STAIR CONFIGURATIONS

Our team of in-house designers can advise on the right stair configuration to suit the specific needs of your project.

STRAIGHT FLIGHT WITH LANDINGS

A simple, but popular configuration with one flight and landings to create floor area. Ease of installation allows each flight and landing to be built to the level of the floor.

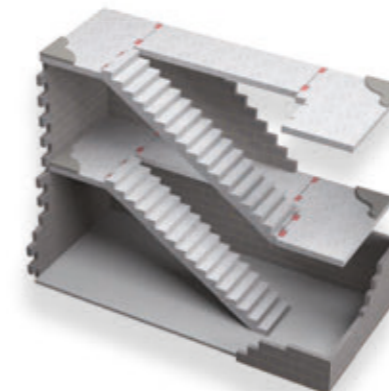

STRAIGHT FLIGHTS WITH CROSS LANDINGS

A simple and cost-effective solution with side support available for both main and half landings. It provides shorter spans to reduce thickness and weight, ensuring easier handling, transportation and installation.



PRECAST WINDING STAIRCASE

Available in L or U shaped configurations, including winders at each turn. This type of stair eliminates the need for half landings.

More stair configurations are available on our website www.forterra.co.uk/bison/stairs-landings, or why not call us on 01636 832000 to see how we can help you with your next project?

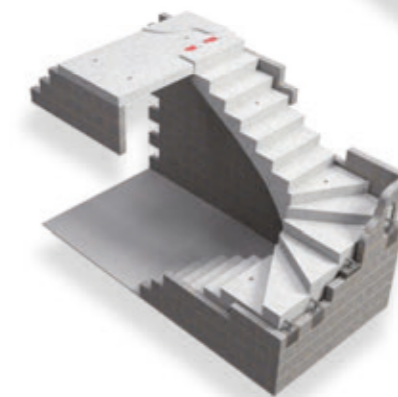

STAIR CONNECTION DETAIL

Connection via mild steel angles, bolted to the head or toe of the stairs and bear onto to support landing or structure.

Stairs supported by steel supports



Stairs supported by pre-cast concrete landing





TECHNICAL SERVICES

TECHNICAL SERVICES AND GENERAL CONSTRUCTION ADVICE

For general construction advice or information about a product's performance and industry best practice on how to use it, our experienced technical team are on hand to answer your questions at every stage of your build.

If your project has hit a brick wall, the team's problem-solving skills are second to none. By involving them from a project's earliest stage, they are able to use their true value engineering know-how to help you make your architectural design concept reality while keeping budgets under control.

Our precast concrete products and services have been developed to help you complete a successful project within a demanding modern environment – providing support from start to finish.

Our design and technical support teams will work with you to help solve problems to overcome the challenges you face. We will provide our valued engineering input throughout the process to ensure you have the most efficient and cost-effective solution.

If your project has hit a brick wall, the team's problem-solving skills are second to none. By involving them from a project's earliest stage, they are able to use their true value engineering know-how to help you make your architectural design concept reality while keeping budgets under control.

BISON TECHNICAL SUPPORT
01636 832000
TECHNICALQUERY@BISON.CO.UK

Problem Resolution

Our extensive technical advice and support helps to avoid problems from occurring in the first place, but should you find yourself in a challenging situation, we do our best to help you to find a satisfactory resolution.

Advise on standards and best practice

Not sure of the requirements for your build? We can provide guidance on standards and Building Regulations to point you in the right direction.

If you're targeting performance above and beyond the basic standards, then the team can advise best practice on the use of Forterra's products to achieve the highest possible performance standards.

BLOCK TECHNICAL SUPPORT
0330 123 1018
ASKTECHNICAL@FORTERRA.CO.UK

EXPERTISE IN ALL SECTORS

We fully understand the sectors within which we work. Whatever your scheme, we can tailor our products – which we manufacture off site – to align exactly. Whatever sector you specialise in, we specialise in it too.

RESIDENTIAL
INDUSTRIAL
AND COMMERCIAL
EDUCATION

STADIA
LEISURE
HEALTHCARE
CAR PARKS

INFRASTRUCTURE
CUSTODIAL
STUDENT
ACCOMMODATION

FOR TECHNICAL SERVICES CALL 01636 832000

THE COMPLETE FORTERRA RANGE

Our extensive product range covers all your construction requirements, from initial ground work through to finished build.

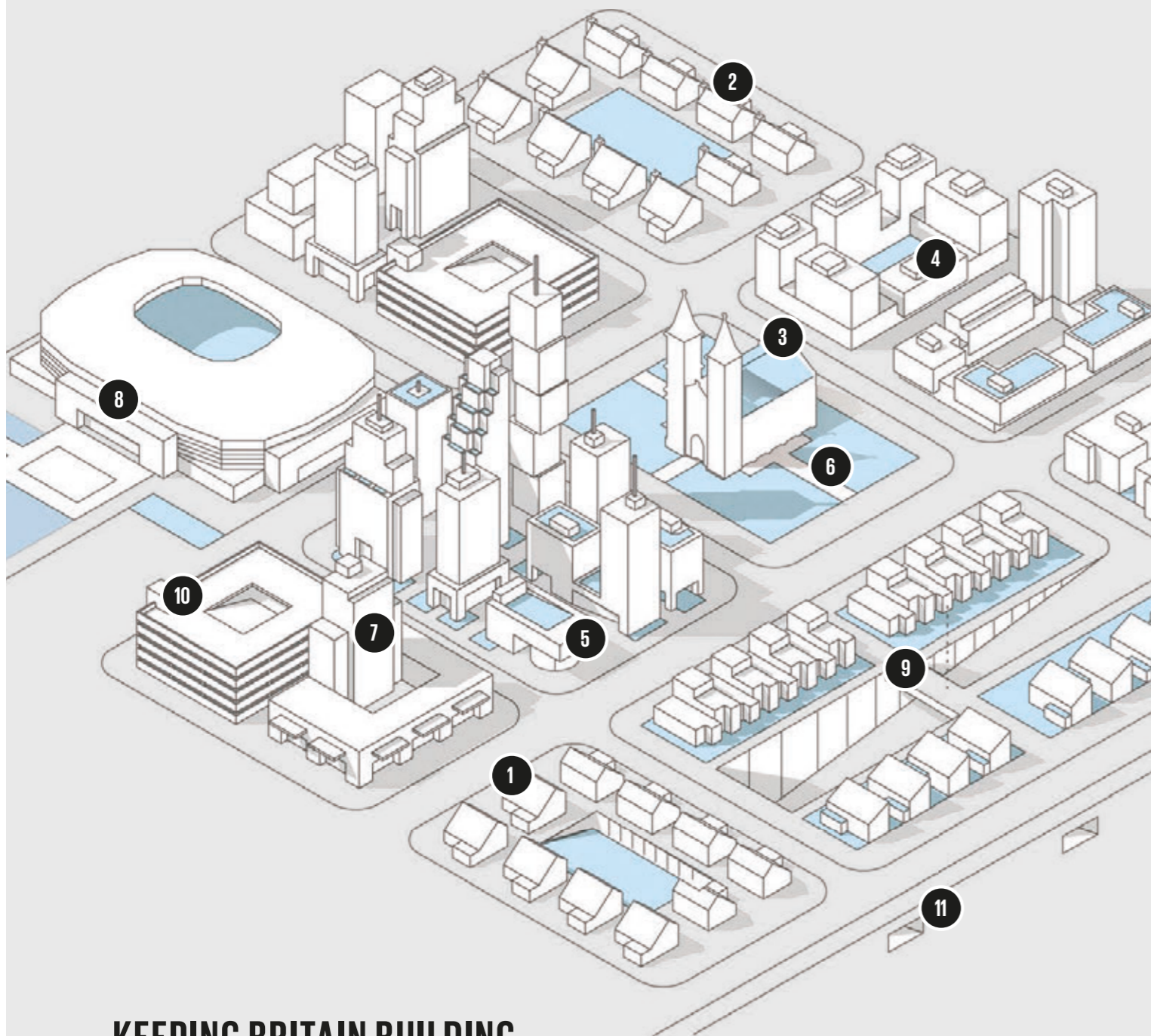

KEEPING BRITAIN BUILDING

1. BRICKS AND BLOCKS

LONDON BRICK
ECOSTOCK
BUTTERLEY
THERMALITE
CONBLOC



2. CHIMNEY AND FLUE SYSTEMS

RED BANK



3. RIDGE TILES AND FINIALS

RED BANK



4. AIR BRICKS AND CAVITY WALL BRIDGING DUCTS

RED BANK



5. SPECIAL SHAPED BRICKS

CRADLEY



6. PERMEABLE PAVING SYSTEMS

FORMPAVE



7. WALLING AND CLADDING SYSTEMS

SUREBRICK
QUICKWALL



8. PRECAST CONCRETE

JETFLOOR
BEAM & BLOCK
HOLLOWCORE



9. PRECAST CONCRETE

OMNIA BRIDGE DECK



10. PRECAST CONCRETE

STAIRS AND LANDINGS



11. PRECAST CONCRETE

BOX CULVERTS



TALK TO OUR SPECIALISTS ON
0370 5626500

forterra.co.uk

Forterra is a leading manufacturer of a diverse range of clay and concrete building products, used extensively within the construction sector, and employs over 1,800 people across 17 manufacturing facilities in the UK.

It is the second largest brick and aircrete block manufacturer in the country, and the only producer of the iconic London Brick. Other trusted brands from Forterra include Thermalite, Conbloc, Ecostock, Butterley, Cradley, Red Bank, Bison Precast and Formpave.

forterra.co.uk

Forterra Building Products Ltd

5 Grange Park Court
Roman Way
Northampton
NN4 5EA

01604 707600

forterra.co.uk



BISON PRECAST



forterra.co.uk